

# DOWNLIGHT 60W BASCULANTE BALERDI

## Características

- Larga vida útil. Más de 50.000 horas
- Alta eficiencia lumínica
- Hasta un 80% de ahorro
- IP 20

## Aplicaciones

- Diseñado para aplicaciones de iluminación general en oficinas, supermercados, tiendas, escuelas, hoteles, etc.
- También se usa frecuentemente para áreas públicas, como escaleras, vestíbulo, recepción, corredores, etc.



## Especificaciones Técnicas del Producto

CCT	3000K	4000K	5000K	5700K
LUMENES	5.300 Lm	5.350 Lm	5.400 Lm	5.450 Lm
POTENCIA	60W			
MODELO	BAL-60W			
REGULABLE	No			
VOLTAJE	AC230V			
FRECUENCIA	50 Hz			
FACTOR DE POTENCIA	≥0.9			
CRI	≥80			
ÁNGULO DEL HAZ	90°			
CORRIENTE SALIDA	1.400 mA			
Tª FUNCIONAMIENTO	-20 ~45°C			
Tª ALMACENAMIENTO	-20 ~65°C			
IP	IP 20			
VIDA ÚTIL	40.000 horas			
DIMENSIONES	L246*W156*H115mm Recorte L225*W130mm			

## Dimensiones

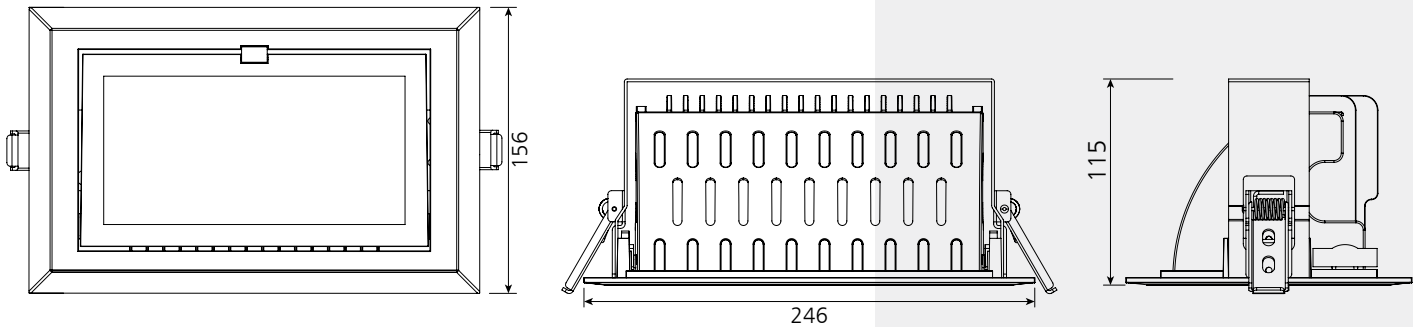

## Información Embalaje

CONTENIDO	MEDIDAS CARTON (cm) L*A*H	PESO BRUTO	PESO NETO
6 PC/CTN	60*29*41,5	16 kg	13,8 kg

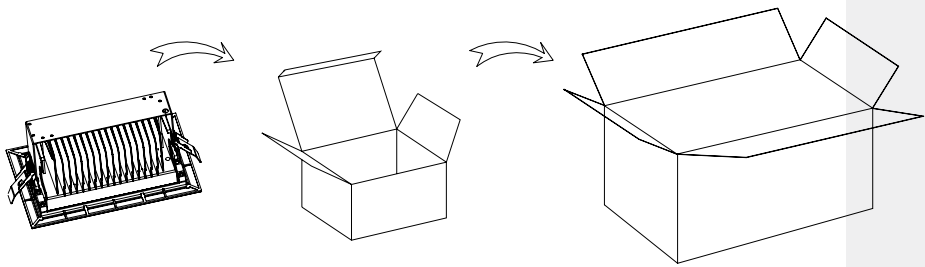

## Especificaciones Ópticas

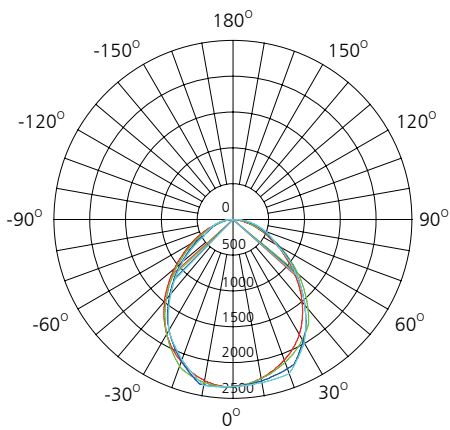

AVERAGE BEAM ANGLE (50%): 95.0DEG

# Especificaciones Ópticas

## 3000 K

## 4000 K

Distribución espectral



Diagrama de intensidad polar



Diagrama cartesiano de intensidad

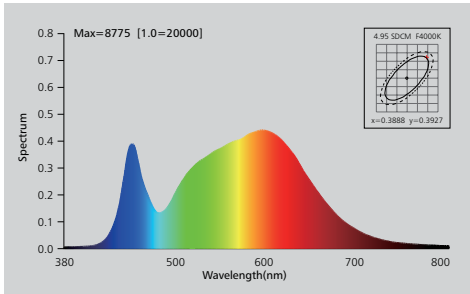
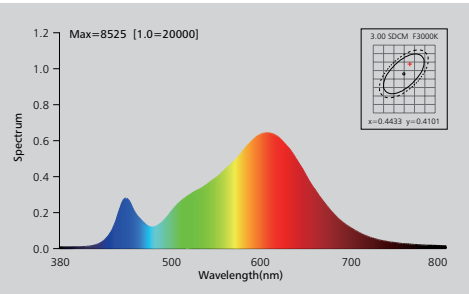

Diagrama de haz

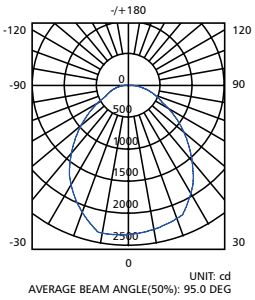
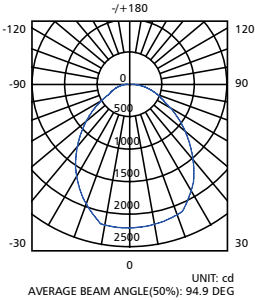

Height Eavg, Emax Angle: 93.04deg Diameter  
 Note: The Curves indicate the illuminated area and the average illumination when the Luminaire is at different distance.

Height Eavg, Emax Angle: 92.78deg Diameter  
 Note: The Curves indicate the illuminated area and the average illumination when the Luminaire is at different distance.

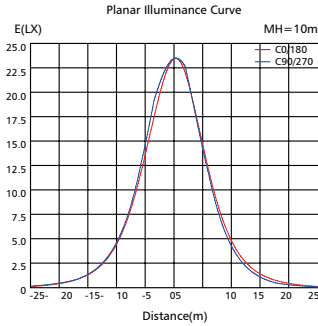
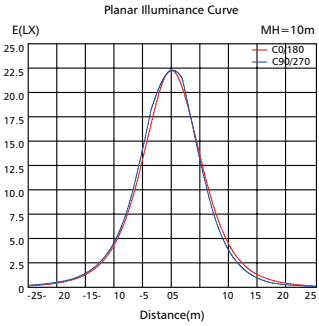
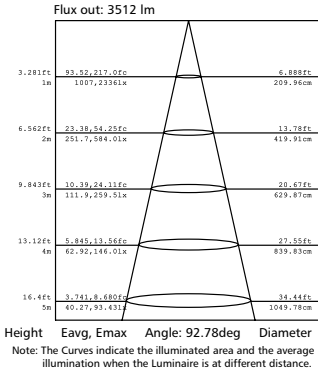
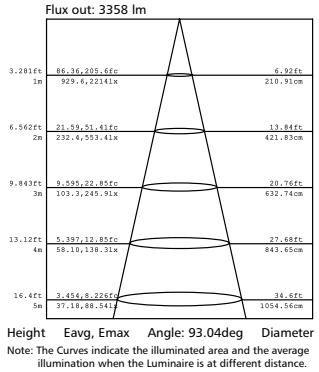
# Especificaciones Ópticas

## 5000 K

## 5700 K

Distribución espectral



Diagrama de intensidad polar



Diagrama cartesiano de intensidad

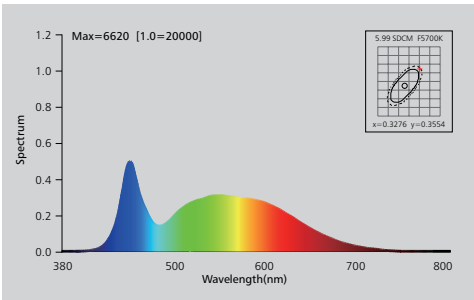
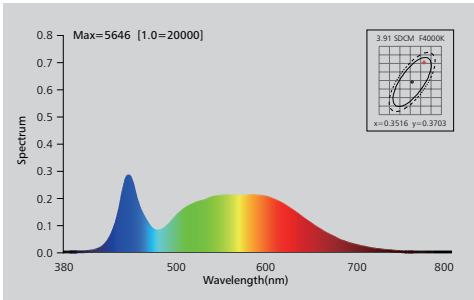

Diagrama de haz

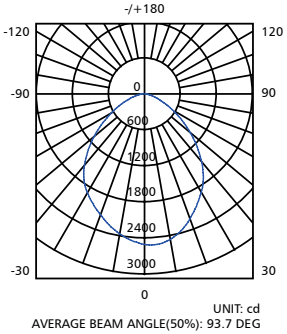
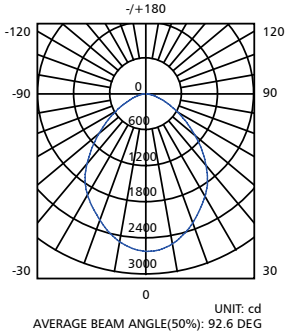

# Instalación

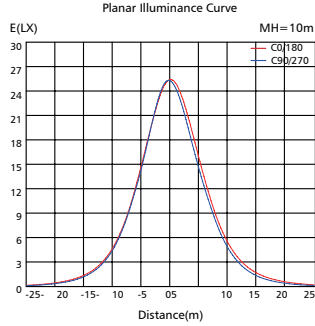
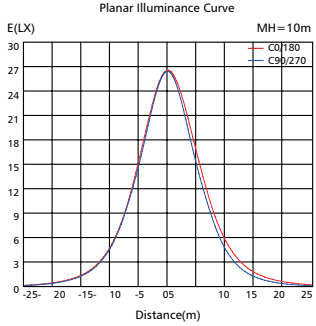
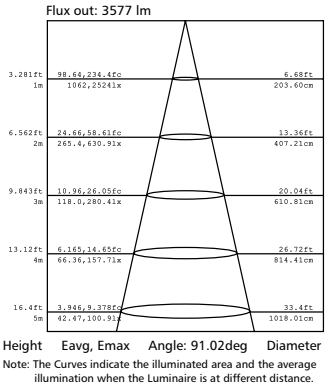
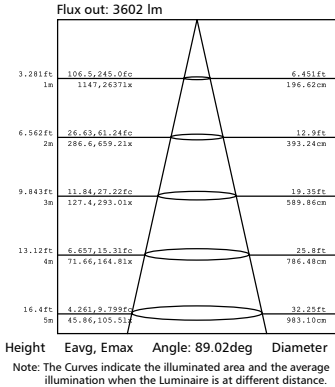
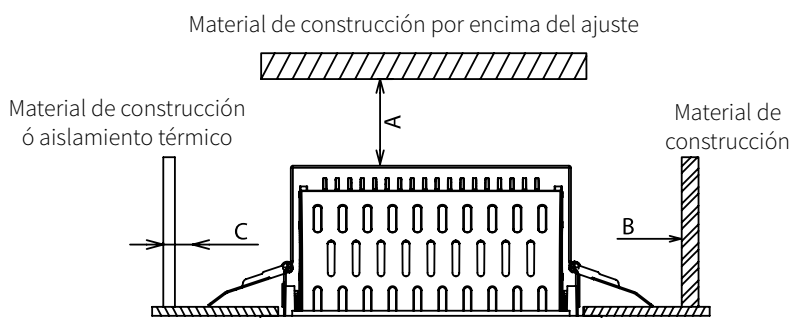

<p><b>Abertura de techo 225*130mm</b></p>	
<p><b>A. Sostenga los clips de resorte</b></p> <p><b>B. Empujar el downlight en su posición</b></p>	

**POESSA, S.A.**

Avda. Cervantes, 35 - C.P. 48970 Basauri - Bizkaia (España)

Tel +84 94 671 30 00

[www.poessa.com](http://www.poessa.com)